

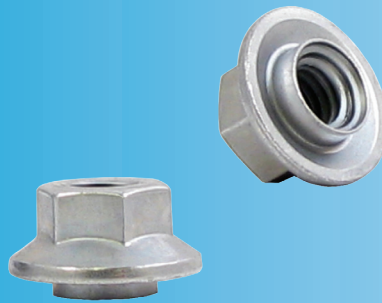

PEM® SFN™ spinning flare nut can eliminate all loose fasteners in thin metal sheet attachment applications.



SFN™

SPINNING FLARE NUT

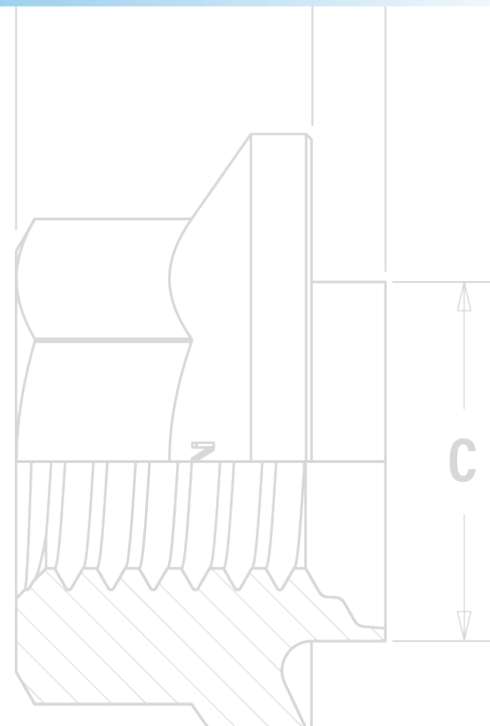
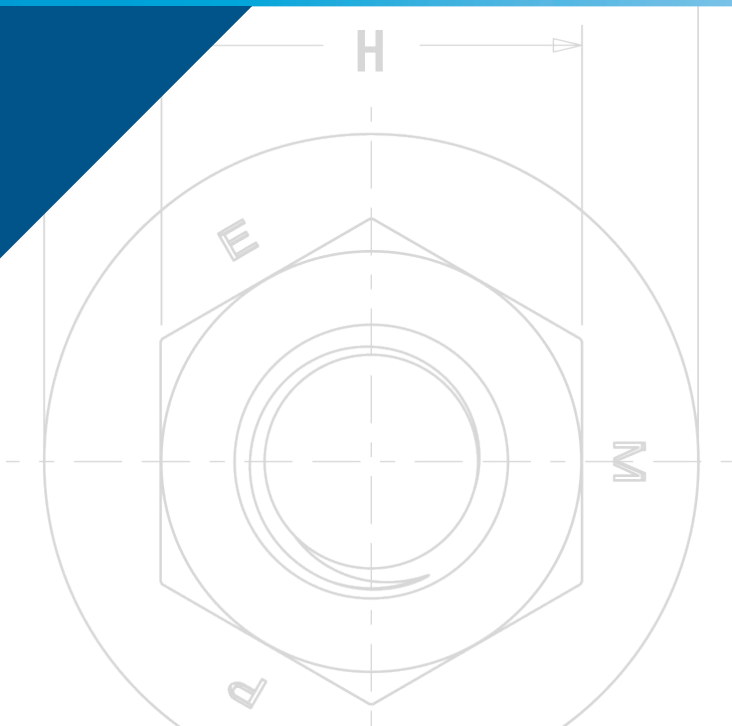

SPINNING FLARE NUT

PEM® SFN™ spinning flare nuts are installed by simply pressing them into a properly sized, pre punched mounting hole. These fasteners are then permanently captivated in the panel but still able to spin freely within the sheet. This allows quick attachment of mating hardware, eliminating much of the need for loose fasteners such as flange nuts. When used with a self-clinching stud or other externally threaded fixed hardware, all loose hardware is eliminated from the applications.

- Installs by pressing into properly sized, pre-punched embossed mounting hole.
- Permanently captive and spins freely in the sheet.
- Quick attachment to mating hardware promotes savings in assembly time and costs.
- Can eliminates all loose hardware including flange nuts.
- Installs into any sheet hardness.

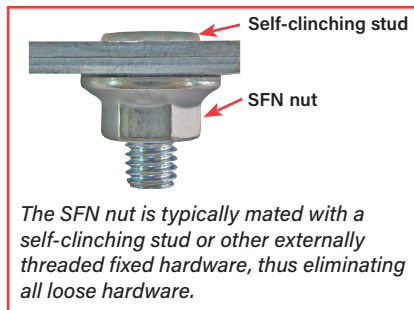

"PEM" Stamp
(Registered
Trademark)

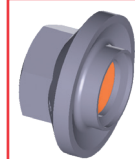

Fastener drawings and models are available at www.pemnet.com

SPINNING FLARE NUT

- Held in place by flaring the fastener
- Rotates freely in sheet
- Installs into any sheet hardness
- Installs into sheets as thin as 1mm

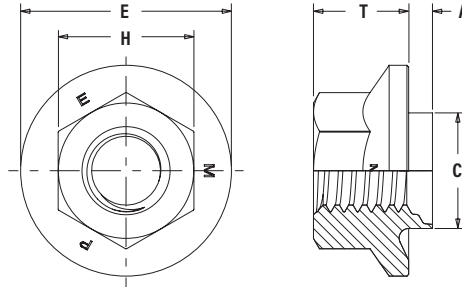
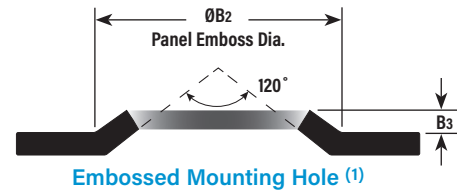
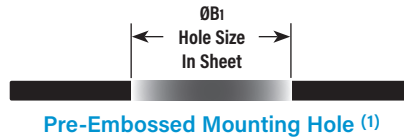

PART NUMBER DESIGNATION

SFN - **M6** - **1** **ZI**
 ↓ ↓ ↓ ↓
 Type Thread Code Length Code Finish

All dimensions are in millimeters.

METRIC	Thread Size x Pitch	Type	Thread Code	Shank Code	A (Shank) Max.	Sheet Thickness ±0.1	ØB1 Hole Size In Sheet +0.08	ØB2 Panel Emboss Dia. Nom.	B3 Panel Emboss Height Nom.	C Max.	E ±0.3	H -0.2	T ±0.25
		Fastener Material											
		Steel											
M5 x 0.8	SFN	M5	1	1.3	1	7.5	10	0.4	7.25	12.8	7.98	6	
			2	1.8	1.5								
M6 x 1	SFN	M6	00	1.3	1	8.75	12.25	0.7	8.5	15.5	9.98	7	
			1	1.8	1.5								
M8 x 1.25	SFN	M8	00	1.3	1	10.5	14.9	1	10.25	20	12.98	9	
			1	1.8	1.5								

(1) Variations in mounting hole size and sheet material hardness may affect results of the hole preparation procedure shown here. For technical assistance, send an e-mail to techsupport@pemnet.com.

MATERIAL AND FINISH SPECIFICATIONS

Threads: Internal, ASME B1.1, 2B / ASME B1.13M, 6H

Material: Carbon steel

Finish: ZI - Zinc plated, 5µm, colorless (2)

For use in: Any sheet hardness

(2) See PEM Technical Support section of our web site (www.pemnet.com) for related plating standards and specifications.



SPINNING FLARE NUT

INSTALLATION

1. Prepare properly sized embossed mounting hole in sheet. Do not perform any secondary operations such as deburring.
2. Insert fastener into the recessed anvil and place the mounting hole (preferably the punch side) over the shank of the fastener.
3. With installation punch and anvil surfaces parallel, apply squeezing force to flare the shank of the fastener.

PEMSERTER® Installation Tooling

Type	Thread Code	Anvil Dimensions (mm)			Flaring Anvil Part Number	Punch Part Number
		A ±0.127	B ±0.025	P Min.		
SFN	M5	14.5	9.5	7.49	8018538	8018670
SFN	M6	19	11.81	8.51	8018539	8018670
SFN	M8	22.61	15.29	10.49	8018540	8018670

If your application requires installation into a flat sheet, please contact our technical support at techsupport@pemnet.com as we have tooling options available.

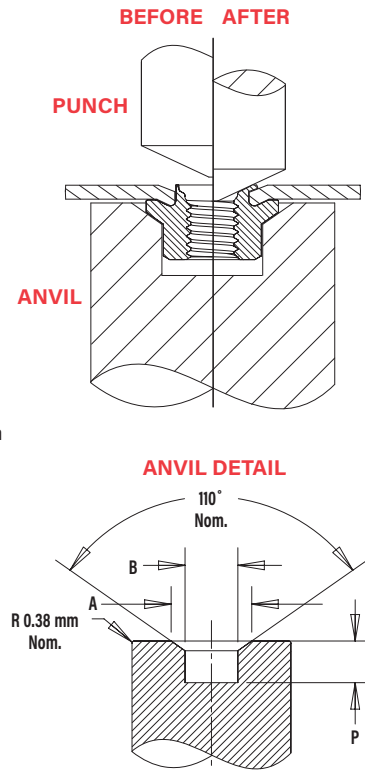

INSTALLATION NOTES

- For best results we recommend using a Haeger® or PEMSERTER® press for installation of PEM self-clinching fasteners. Please check our website for more information.
- Visit the Animation Library on our website to view the installation process [for select products](#).

PERFORMANCE DATA⁽¹⁾

METRIC	Type	Thread Code	Shank Code	Test Sheet Material					
				Stainless Steel		Cold-rolled Steel		Aluminum	
				Installation (kN)	Pushout (N)	Installation (kN)	Pushout (N)	Installation (kN)	Pushout (N)
SFN	M5		1	7.2	862	7.2	642	5.8	428
			2	7.2	1261	7.2	1261	5.8	1261
SFN	M6		00	12.9	964	12.9	642	12.9	428
			1	12.9	1431	12.9	1431	12.9	1329
SFN	M8		00	12.9	964	12.9	642	12.9	642
			1	12.9	1431	12.9	1431	12.9	1329

(1) Published installation forces are for general reference. Actual set-up and confirmation of complete installation should be made by observing proper seating of fastener as described in the installation steps. Other performance values reported are averages when all proper installation parameters and procedures are followed. Variations in mounting hole size, sheet material, and installation procedure may affect performance. Performance testing this product in your application is recommended. We will be happy to provide technical assistance and/or samples for this purpose.

All PEM® products meet our stringent quality standards. If you require additional industry or other specific [quality certifications](#), special procedures and/or part numbers are required. Please contact your local sales office or representative for further information.

Regulatory [compliance information](#) is available in Technical Support section of our website. Specifications subject to change without notice. See our website for the most current version of this bulletin.

PennEngineering®



North America: Danboro, Pennsylvania USA • E-mail: info@pemnet.com • Tel: +1-215-766-8853 • 800-237-4736 (USA)

Europe: Galway, Ireland • E-mail: europa@pemnet.com • Tel: +353-91-751714

Asia/Pacific: Singapore • E-mail: singapore@pemnet.com • Tel: +65-6-745-0660

Shanghai, China • E-mail: china@pemnet.com • Tel: +86-21-5868-3688