

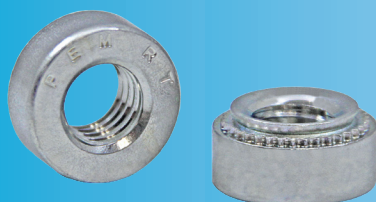

PEM® brand RT™ free-running locknuts have a thread form that creates a lock when clamp load is applied

**NEW**



# S-RT™

## FREE-RUNNING LOCKNUTS

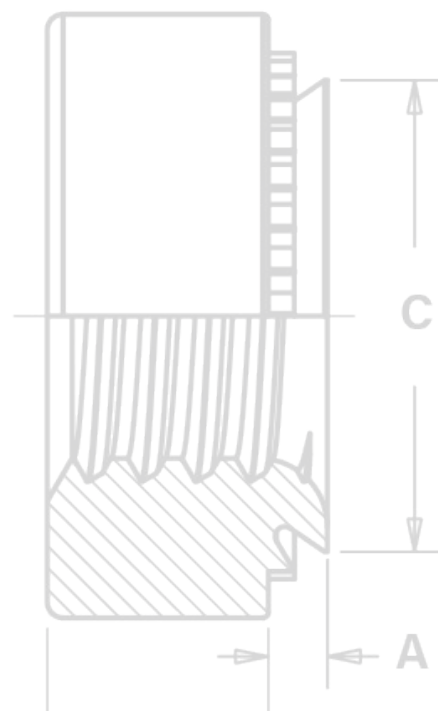

# PEM® S-RT™ FREE-RUNNING LOCKNUTS

Free-running locking feature allows screw to turn freely until clamp load is applied. If the tightening force is removed, these nuts no longer provide any torsional resistance to rotation.

- Resistant to vibrational loosening.
- Back side of panel is flush or sub-flush for screw installation.
- Locking feature reusability is not affected by number of on/off cycles.
- Uses same mounting hole and installation tooling as standard S™ nuts.
- Recommended for use in steel or aluminum sheets HRB 80 / HB 150 or less.

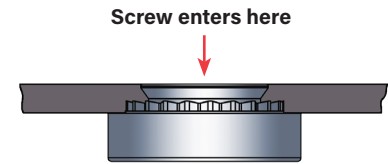

The graph below represents the clamp load of the joint versus the amount of cycles during transverse vibration testing for an S-RT™ free-running locknut, a standard S nut, a split ring lock washer and Loctite Red 271.

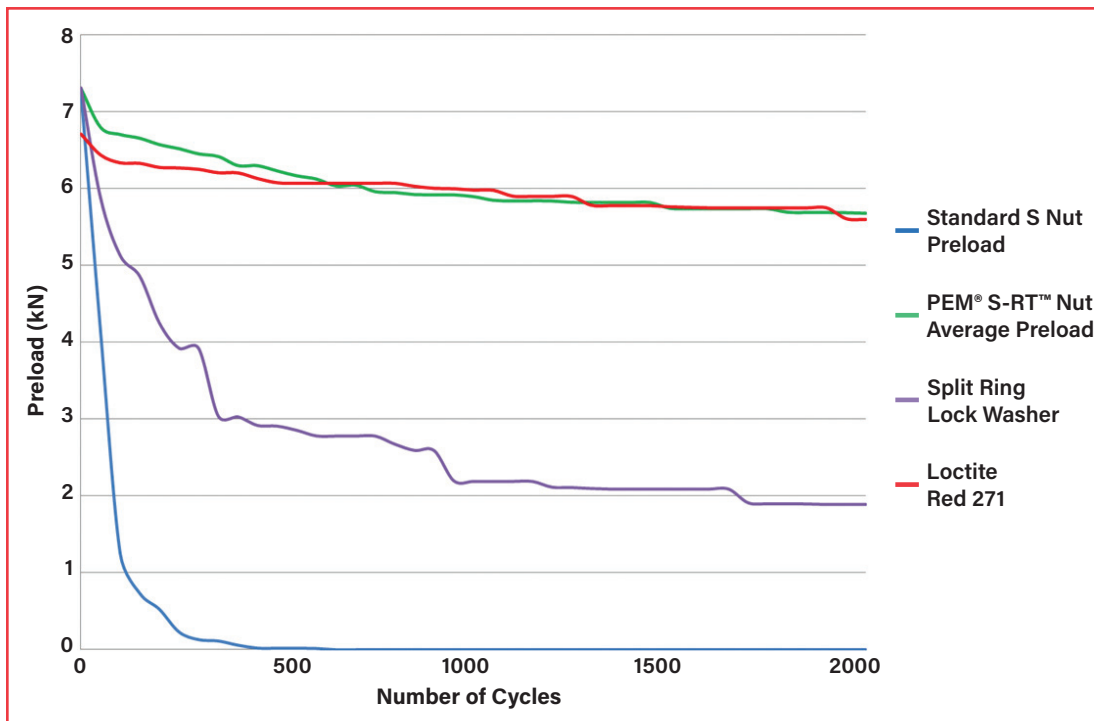

### Testing conditions:

Transverse vibration testing.  
M6 thread size nuts, average of 30 pieces.  
Clamp load applied using metric property class 10.9 screws.  
Nuts tested until loss of clamp load or 2,000 cycles is reached.

[Click here](#) for details on the "PEM® RT™ Vibration Resistant Thread Technology" tech sheet.

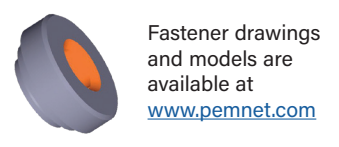
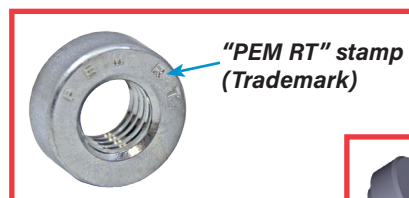

# PEM® S-RT™ FREE-RUNNING LOCKNUTS

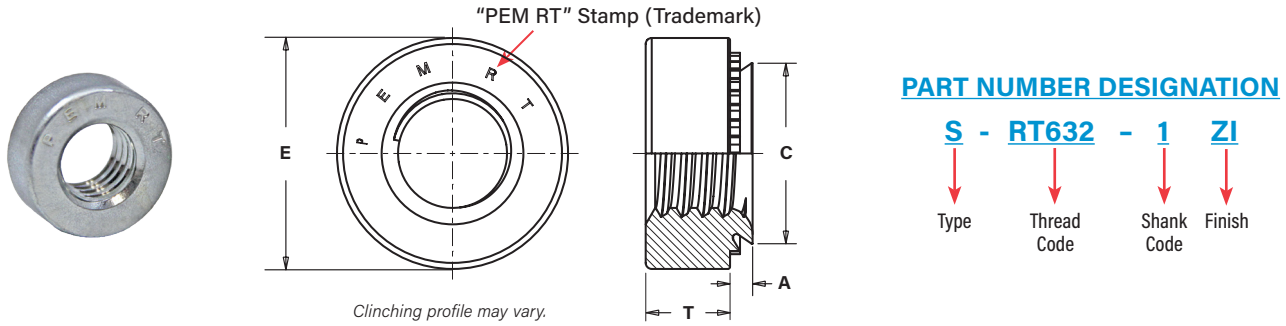

All dimensions are in inches.

UNIFIED	Thread Size	Type	Thread Code	Shank Code	A (Shank) Max.	Rec. Min. Sheet Thickness (1)	Hole Size In Sheet +.003 -.000	C Max.	E ±.010	T ±.010	Min. Dist Hole To Edge
	.112-40 (#4-40)	S	RT440	0	.030	.030	.166	.165	.250	.070	.19
			1	.038	.040						
			2	.054	.056						
.138-32 (#6-32)	S	RT632	0	.030	.030	.1875	.187	.280	.070	.22	
			1	.038	.040						
			2	.054	.056						
.164-32 (#8-32)	S	RT832	0	.030	.030	.213	.212	.310	.090	.27	
			1	.038	.040						
			2	.054	.056						
.190-32 (#10-32)	SS	RT032	0	.030	.030	.250	.249	.340	.090	.28	
			1	.038	.040						
			2	.054	.056						
.250-20 (1/4-20)	S	RT0420	0	.045	.047	.344	.343	.440	.170	.34	
			1	.054	.056						
			2	.087	.090						
.313-18 (5/16-18)	S	RT0518	1	.054	.056	.413	.412	.500	.230	.38	
			2	.087	.090						

All dimensions are in millimeters

METRIC	Thread Size x Pitch	Type	Thread Code	Shank Code	A (Shank) Max.	Rec. Min. Sheet Thickness (1)	Hole Size In Sheet +0.08	C Max.	E ±0.25	T ±0.25	Min. Dist Hole To Edge
	M3 x 0.5	S	RTM3	0	0.77	0.8	4.22	4.2	6.35	1.5	4.8
1				0.97	1						
2				1.38	1.4						
M4 x 0.7	S	RTM4	0	0.77	0.8	5.41	5.38	7.87	2	6.9	
			1	0.97	1						
			2	1.38	1.4						
M5 x 0.8	SS	RTM5	0	0.77	0.8	6.35	6.33	8.64	2	7.1	
			1	0.97	1						
			2	1.38	1.4						
M6 x 1	S	RTM6	00	0.89	0.92	8.75	8.73	11.18	4.08	8.6	
			0	1.15	1.2						
			1	1.38	1.4						
			2	2.21	2.29						
M8 x 1.25	S	RTM8	1	1.38	1.4	10.49	10.47	12.7	5.84	9.65	
			2	2.21	2.29						

## MATERIAL AND FINISH SPECIFICATIONS

**THREADS:** Modified thread form on loaded flank. Will accept a maximum material 6g/2A screw.

**FASTENER MATERIAL:** Hardened Carbon Steel

**FINISH<sup>(2)</sup>:** Standard: ZI - Zinc plated, 5µm, colorless

Optional: ZC - Zinc plated, 5µm, yellow

**FOR USE IN SHEET HARDNESS:** HRB 80 (Hardness Rockwell "B" scale) / HB 150 (Hardness Brinell) or less

(1) For maximum performance, we recommend that you use the maximum shank length for your sheet thickness.

(2) See PEM [Technical Support](#) section of our website for related plating standards and specifications.



# PEM® S-RT™ FREE-RUNNING LOCKNUTS

## INSTALLATION

1. Prepare properly sized mounting hole in sheet. Do not perform any secondary operations such as deburring.
2. Place fastener into the anvil hole and place the mounting hole (preferably the punch side) over the shank of the fastener as shown in diagram.
3. With installation punch and anvil surfaces parallel, apply squeezing force until the head of the nut comes into contact with the sheet material.

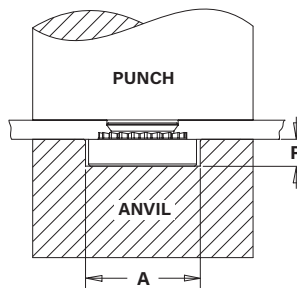

### INSTALLATION NOTES

- For best results we recommend using a PEMSERTER® press for installation of PEM self-clinching fasteners. Please check our website for more information.
- Visit the Animation Library on our website to view the installation process for [select products](#).

## PEMSERTER® Installation Tooling

UNIFIED	Thread Code	Anvil Dimensions (in.)		Anvil Part Number	Punch Part Number
		A ±.002	P ±.005		
	RT440	.267	.045	975200034	975200048
	RT632	.298	.045	975200035	975200048
	RT832	.330	.070	975200036	975200048
	RT032	.361	.070	975200037	975200048
	RT0420	.454	.150	975200038	975200048
	RT0518	.517	.200	975200039	975200048

METRIC	Thread Code	Anvil Dimensions (mm)		Anvil Part Number	Punch Part Number
		A ±0.05	P ±0.13		
	RTM3	6.78	1.14	975200034	975200048
	RTM4	8.38	1.78	975200036	975200048
	RTM5	9.17	1.78	975200037	975200048
	RTM6	11.53	3.81	975200038	975200048
	RTM8	13.08	5.08	975200039	975200048

## PERFORMANCE DATA<sup>(1)</sup>

UNIFIED	Type	Thread Code	Shank Code	Test Sheet Material	Installation (lbs.)	Pushout (lbs.)	Torque-out (in. lbs.)
	S	S	RT440	0	5052-H34 Aluminum	1500-2000	63
1				90			10
2				170			13
0				Cold-rolled Steel	105		13
1					125		15
2					230		18
S		RT632	0	5052-H34 Aluminum	2500-3000	63	16
			1			95	17
			2			190	22
			0	Cold-rolled Steel		110	16
			1			130	20
			2			275	28
S	RT832	0	5052-H34 Aluminum	2500-3000	68	21	
		1			105	23	
		2			220	35	
		0	Cold-rolled Steel		110	26	
		1			145	35	
		2			285	45	
SS	RT032	0	5052-H34 Aluminum	2500-3500	68	26	
		1			110	32	
		2			190	50	
		0	Cold-rolled Steel		120	32	
		1			180	40	
		2			320	60	
S	RT0420	0	5052-H34 Aluminum	4000-7000	220	70	
		1			360	90	
		2			125	125	
		0	Cold-rolled Steel		315	115	
		1			400	150	
		2					
S	RT0518	1	5052-H34 Aluminum	4000-7000	380	120	
		2			160		
		1	Cold-rolled Steel		420	165	
		2			180		

METRIC	Type	Thread Code	Shank Code	Test Sheet Material	Installation (kN)	Pushout (N)	Torque-out (N-m)
	S	S	RTM3	0	5052-H34 Aluminum	6.7-8.9	280
1				400			1.13
2				750			1.47
0				Cold-rolled Steel	470		1.47
1					550		1.7
2					1010		2.03
S		RTM4	0	5052-H34 Aluminum	11.2-13.4	300	2.37
			1			470	2.6
			2			970	4
			0	Cold-rolled Steel		490	2.95
			1			645	4
			2			1250	5.1
SS	RTM5	0	5052-H34 Aluminum	11.2-15.6	300	3	
		1			480	3.6	
		2			845	5.7	
		0	Cold-rolled Steel		530	3.6	
		1			800	4.5	
		2			1420	6.8	
S	S	RTM6	00	5052-H34 Aluminum	18-32	750	6.5
			0			970	7.9
			1			1580	10.2
			2	14.1		14.1	
			00	Cold-rolled Steel		900	10
			0			1380	13
	1	1760	17				
	S	RTM8	1	5052-H34 Aluminum	18-32	1690	13.6
			2			18.1	
			1	Cold-rolled Steel		1865	18.7
2			20.3				

(1) Published installation forces are for general reference. Actual set-up and confirmation of complete installation should be made by observing proper seating of fastener as described in the installation steps. Other performance values reported are averages when all proper installation parameters and procedures are followed. Variations in mounting hole size, sheet material, and installation procedure may affect performance. Performance testing this product in your application is recommended. We will be happy to provide technical assistance and/or samples for this purpose.

All PEM® products meet our stringent quality standards. If you require additional industry or other specific [quality certifications](#), special procedures and/or part numbers are required. Please contact your local sales office or representative for further information.

Regulatory [compliance information](#) is available in Technical Support section of our website. Specifications subject to change without notice. See our website for the most current version of this bulletin.

**PennEngineering®**



**North America:** Danboro, Pennsylvania USA ■ E-mail: [info@pemnet.com](mailto:info@pemnet.com) ■ Tel: +1-215-766-8853 ■ 800-237-4736 (USA)

**Europe:** Galway, Ireland ■ E-mail: [europa@pemnet.com](mailto:europa@pemnet.com) ■ Tel: +353-91-751714

**Asia/Pacific:** Singapore ■ E-mail: [singapore@pemnet.com](mailto:singapore@pemnet.com) ■ Tel: +65-6-745-0660

Shanghai, China ■ E-mail: [china@pemnet.com](mailto:china@pemnet.com) ■ Tel: +86-21-5868-3688